

K12
USER MANUAL v3.0

What's Included

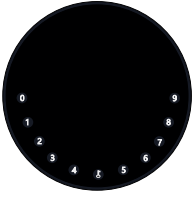

1 x KeyBox



1 x HELLO Card



2 x Screw Cap

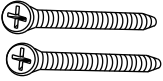

2 x Mounting Screws



2 x Screws Anchors



1 x Reset Tool

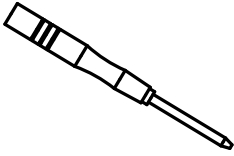

Screw Driver x 1

Specification

Model	K12
Material	Body Zinc Alloy, SUS304
Battery	4 x AAA Alkaline Battery
Unlock Mechanism	Bluetooth, PIN Code, App
Jump Start	USB-C

Front

Inside

Back

120mm (4- 7/10")

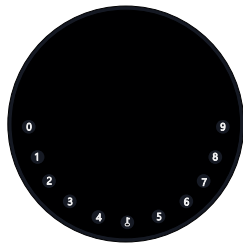

120mm (4- 7/10")

Depth

22mm (4/5 ")

120mm (4- 7/10")

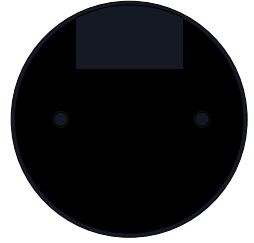

120mm (4- 7/10")

Features

Lock&Unlock



Administrator Unlock

Set a Master Administrator PIN for Unlocking, settings, operations etc. and only the administrator could change the administrator PIN code.



Anti-peeping

Add up to 10 digits before and after PIN code to intensify your PINs.



User Unlock

This KeyBox allows to add up to 100 user PIN codes for your family, friends and visitors.



Auto Locking

If there are no opening motions in 10 seconds the box will be automatically locked.

Mobile Control



Bluetooth one-touch unlock

With your Mobile you could unlock the KeyBox by tapping the "🔒" on the App.



Offline Unlock

You could generate offline code through mobile App, for scheduled access, parcel delivery, housekeeping, etc.



Mobile Administrator

Set Administrator PIN Codes from your Mobile to unlock, add users, delete users, etc.

Battery



Battery Life

4 AAA batteries, the life cycle will be more than 12 months, please use good batteries.



Low Battery

When the battery runs out of power, system will remind you to replace the batteries.



Low Consumption

BLE broadcasting turns to sleep mode if no operations.

Emergency



Jump Start

When the power is down and use USB-C to jump start the lock and get it unlocked



System Lockdown

The lock will be lockdown for 5 minutes if continuously enter wrong PINs for 5 times.

Quick Start

Step 1 > Install Battery

>. Remove the (4) screws on the battery cover

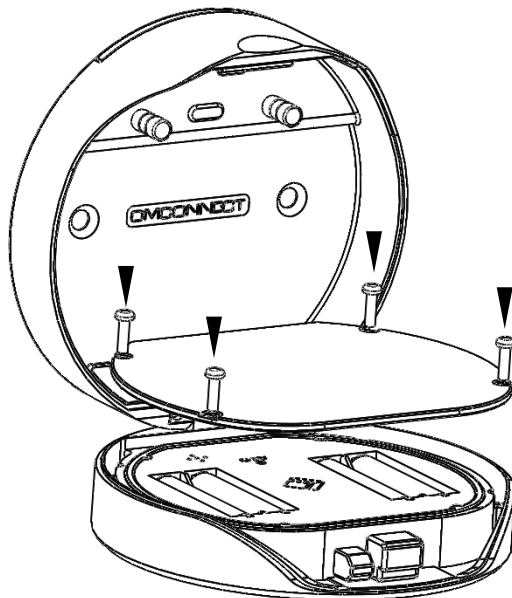

>. Put 4 AAA batteries into the battery dock.

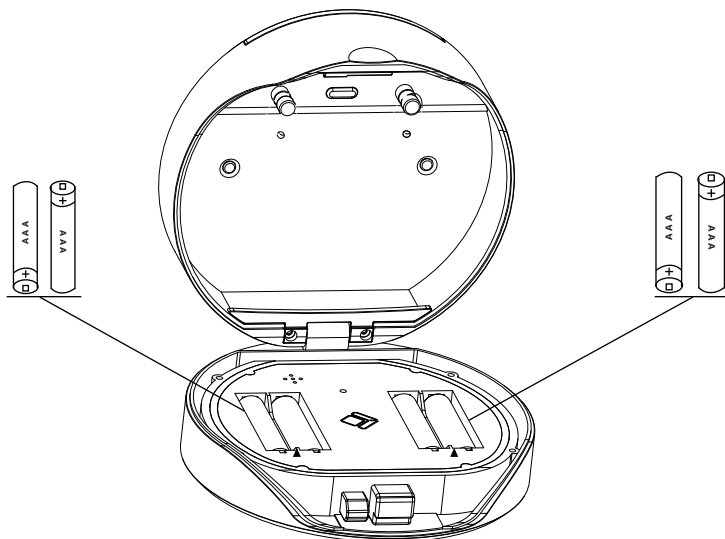

Step 2>Download Mobile App

>1. Scan QR Code below and download the App and turn on your mobile Bluetooth



Step 3>Add Device

>1.Go to App Home page, click Add Device or click "+" on the upper right.

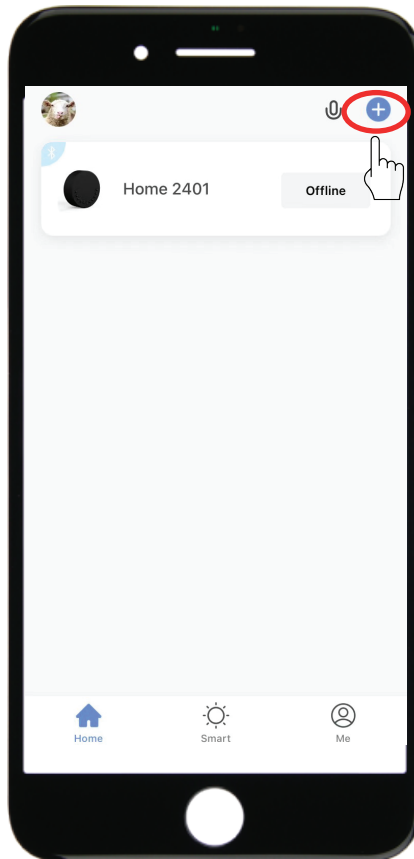

> **2.** Press **⏏** +9+ **⏏** and enter Admin password + **⏏** , when the light slowly blinks in blue the KeyBox is ready to pair.

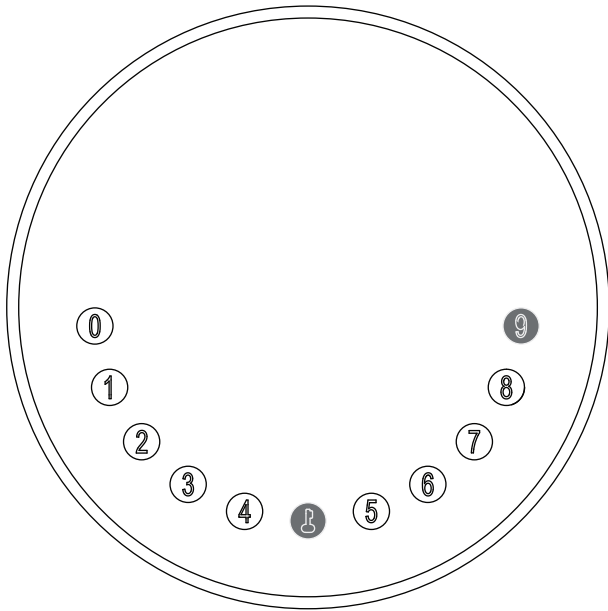

>3. You will see the detected device and click "Go to add".

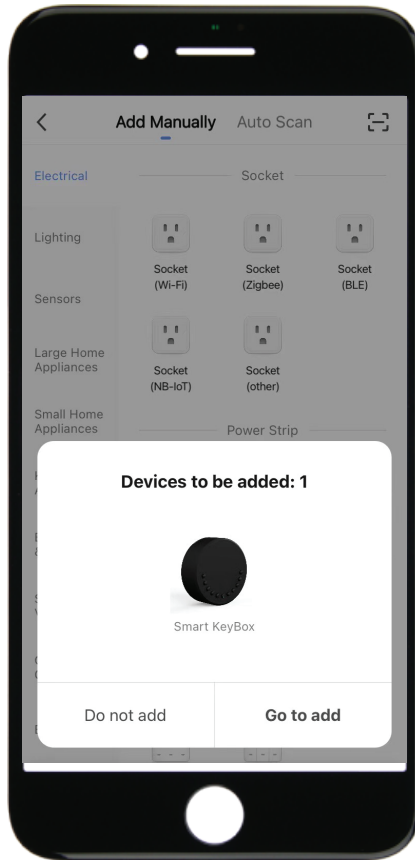

>4. Connecting, you need to wait for few seconds to let it finish.

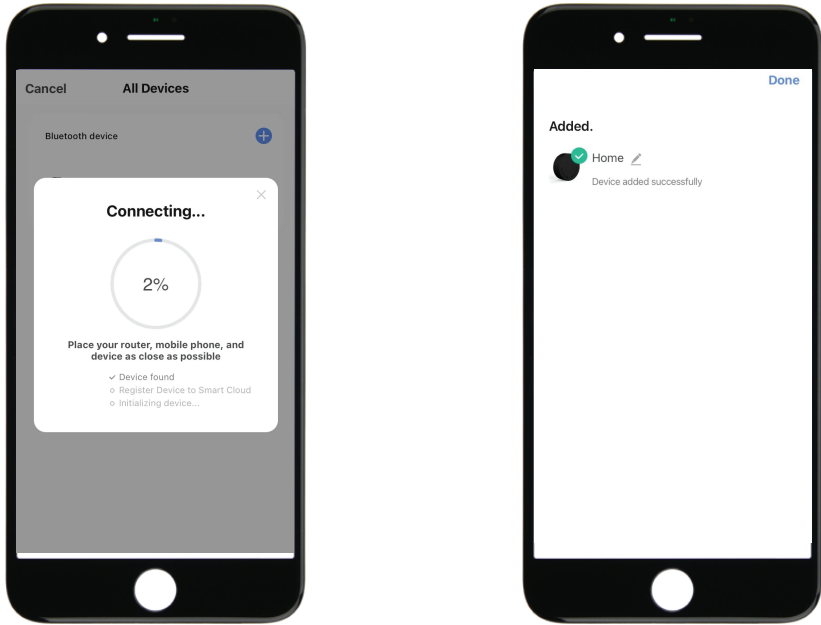

>5. Device added

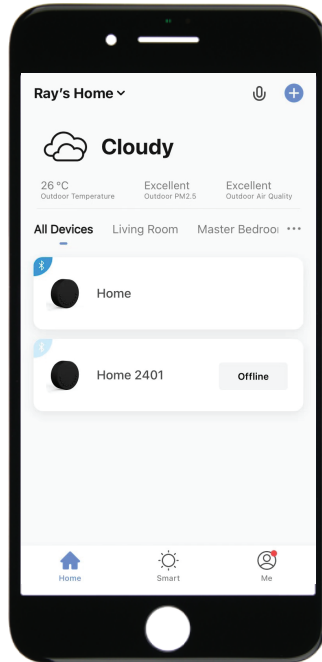

Step 4>Change Admin Password-Initial Admin Password:123456

>1. Press **↓** and hold for 3 beeps

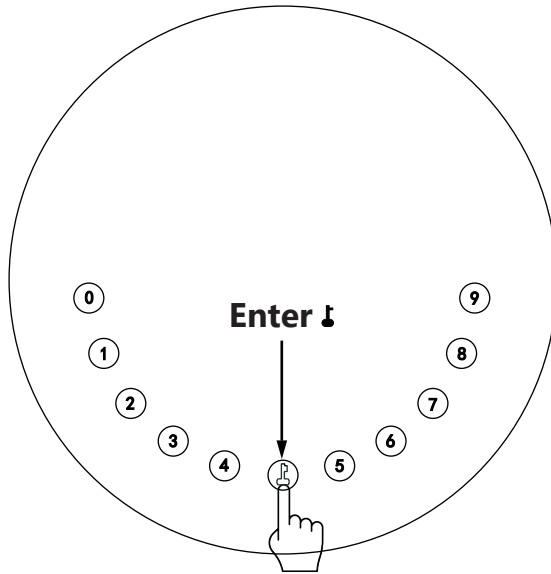

>2. Right after the 3 beeps please key in:

Initial Admin Password + **↓**+new admin password+ **↓**+new admin password+ **↓**

Mechanical Instructions

Password & Factory Mode:

1. Password Length

Password must be 6 digits (no more no less)

2. Add User Password

- Press **⏏** + 0 + **⏏** until the blue light blinks
 - > . Enter admin password + **⏏**
 - > . Enter new user password + **⏏**
 - > . Enter new user password again and press **⏏**
 - > . When the **⏏**(Enter button) blinks in green, user password has been set.

3. Delete User Password

- Press **⏏** + 2 + **⏏** until the blue light blinks
 - > . Enter admin password and press **⏏**
 - > . Enter the user password you wish to delete and press **⏏**
 - > . Enter the user password again and press **⏏**
 - > . When the **⏏**(Enter button) blinks in green the password has been deleted.

4. Delete All User Password

- Press **⏏** + 00000 + **⏏** until the blue light blinks
 - > . Enter admin password and press **⏏**
 - > . When the **⏏**(Enter button) blinks in green all passwords have been deleted.

5. Virtual digits-Anti Peeping

Add any digits before and after the correct password the KeyBox unlock as always

6. System Lockdown

KeyBox will Lockdown for 5 minutes if entering wrong password continuously 5 times

7. Reset Factory Mode

Press and hold the reset button for 5 seconds and with a long beep

Bluetooth broadcasting & re-connecting:

Bluetooth broadcasting will turn to sleep mode if no operations within 1 minute.

Press any key to activate the Bluetooth, App&Device will get reconnected each other.

App Instructions

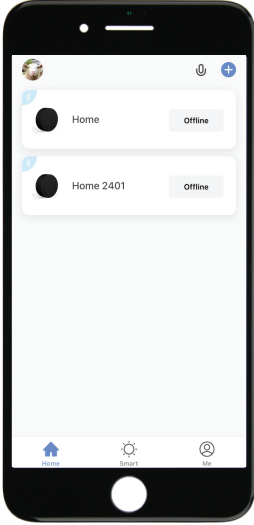

- ☑ You will see all devices and rooms on the home page.
- ☑ Tap the Device to start operating.
- ☑ Tap “Me” at the bottom to manage your home.

- ☑ Touch the lock sign to unlock and lock.
- ☑ Tap “Bell” sign to check the alarm records.
- ☑ Tap “Member Management” to add or delete members.
- ☑ Tap “opening record” to check opening logs.
- ☑ Tap “Intelligent Linkage” to turn on and off go home mode.
- ☑ Tap “Set” to manage passwords

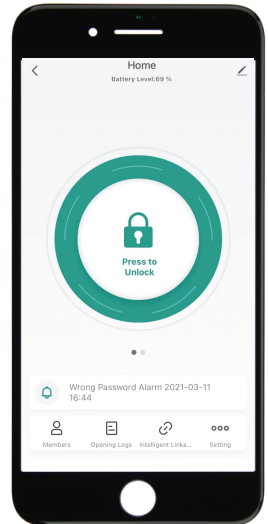

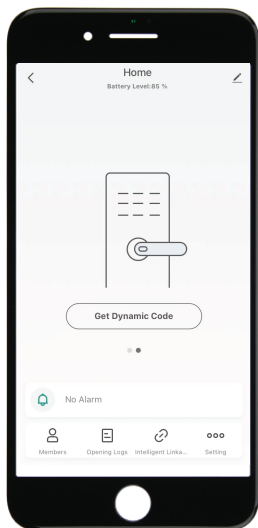

☑ Tap “Get dynamic code” to get a code.

☑ Tap “copy code” and send it to friend or family.

☑ Tap “Pen” sign to edit your personal information.

☑ Go to “Members” to add family or other members

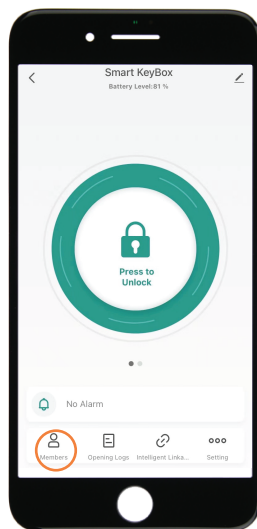

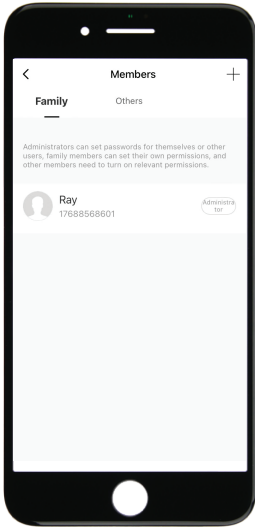

☒ Tap “+” to add family member or other members

☒ Tap “Add it now” under Family to add family members.

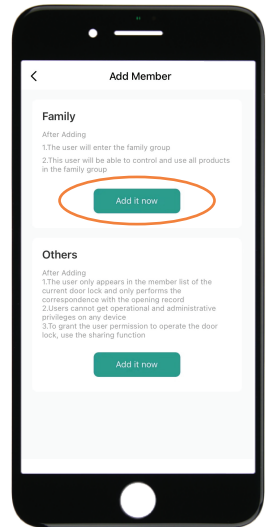

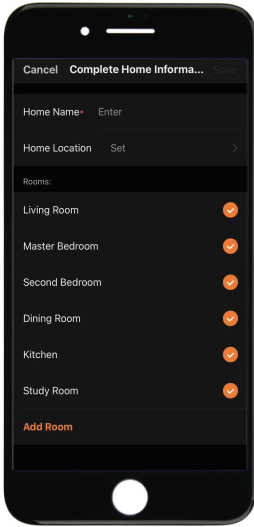

☑ Owner need to complete the Home information before adding any family member if required

☑ The member need to be registered to the App before adding as a family member

☑ Fill up member information and set the role of the member

☑ Tap "Save" to complete and the member will be able to operate the device on his App

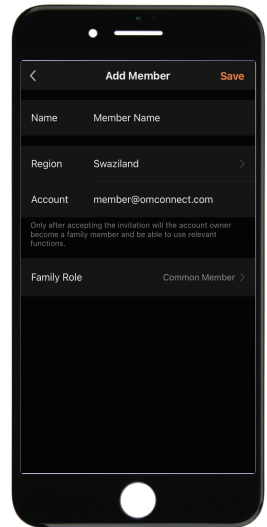

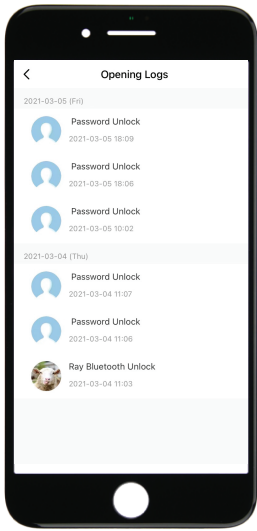

☑ Go to "Opening Logs" to check the unlocking history

☑ With this feature you will be able to find out when and who unlocked the KeyBox

☑ Go to "Intelligent Linkage" to set more smart functions

☑ Tap the green bar to turn on "Family go home" function.

☑ Tap the orange bar to turn on "Door lock alarm" function

☑ You will get notification if user unlocked with Bluetooth

☑ Go to "me" homepage and got to message center to check the records.

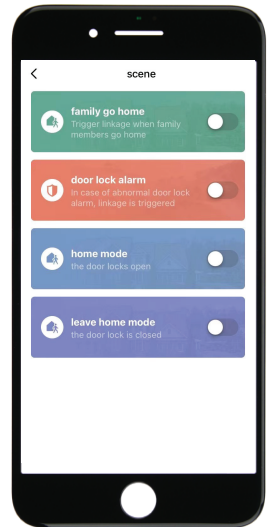

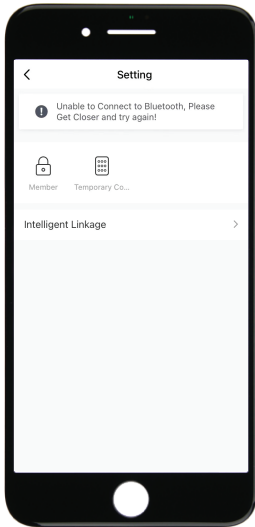

☑ Tap “password management” to add or remove codes.

☑ Tap “Temporary code” to manage online and offline codes.

☑ Tap “one-time code” under Online Code to set an online one time code.

☑ Tap “periodic Code” under Online Code to set an online code which will be available in a period of time.

☑ Tap “One-Time Code” under Offline Code to generate a one time offline code which will be a 10 digits code and use it when the device is offline.

☑ Tap “Offline Temporary Code” under Offline Code to generate an offline code (10 digits) which will be available in a period of time, and use when the device is offline or Bluetooth disconnected with device.

☑ Tap “Clear Code” to generate a code (10 digits) which is able to clear Codes that need to be invalid or clear all codes.

☑ Please note if the code less than 10 digits you need to regenerate a new code, the code must be 10 digits.

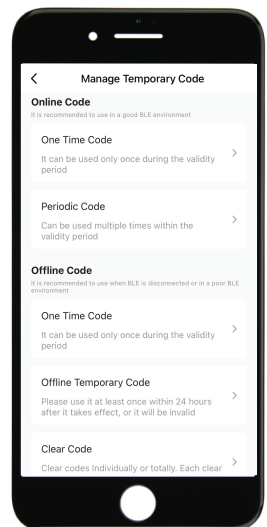

OMUARK

WWW.OMUARK.COM